

Operating Instructions

Melt pressure transducer

DAI



Certified to
ISO 9001:2008

Please read this instruction manual carefully before installing the transducer

Contents:

1. Introduction
2. Operating range and field of application
3. Danger areas
4. Waste disposal
5. Transport and storage
6. Cleaning of the sensors
7. Installing / Uninstalling
8. Connecting and commissioning of the DAI
9. Technical data
10. Dimensions

1. Introduction

Melt pressure transducers are precise measuring probes which obtain their measuring accuracy and long life span only if they are properly handled. These operating instructions should be studied carefully before installing the sensor, thus ensuring a trouble-free operation. Nevertheless, should you encounter any difficulties, please feel free to contact our service technicians, who will be pleased to be of assistance.

2. Operating range and field of application:

Gneuss melt pressure transducers have exclusively been designed for the pressure monitoring of liquid, doughy or pasty materials at high temperatures. These must have a homogeneous constitution. The application area has to be selected in such a manner, that a max. differential pressure of 2 % of the measuring range – based on the diaphragm surface - is not exceeded. Any use beyond the above mentioned application area does not conform to regulations.

3. Danger areas:

In the complete application area of the melt pressure transducer, there is a risk of combustion. If the pressure transducer is not installed or uninstalled correctly during the applying of pressure there is a risk of hot media emerging.

4. Waste disposal:

Pressure transducers filled with mercury, have to be disposed of as hazardous waste. A free of charge and ecologically-friendly disposal can be carried out by Gneuss Kunststofftechnik GmbH.

5. Transport and storage:

Gneuss pressure transducers are generally dispatched in separate packages. In case of mechanical exposure, the sensing diaphragm is protected by an aluminium cap. This cap should be screwed on at all times of storage.

6. Cleaning of the sensors

In order to clean the diaphragm, the sealing surface and the process thread the sensor must have the same temperature as the plastic melting point. The diaphragm and the sealing surface can be wiped down with a soft cloth, the thread can be cleaned with a steel brush.

(Do not come into contact with the diaphragm surface)

7. Installing / Uninstalling

Installing

On installation of the pressure transducer it is imperative to note, that the sensor bore corresponds to the dimensions mentioned below. The fitting accuracy can be checked by means of a test bolt. Prior to mounting the sensor, the thread should be covered with a heat resistant paste. Should the machinery with the sensor drilling still be at production temperature, a certain preheating period for the sensor should be taken into consideration, in order to avoid a seizing of the sensor due to thermal expansion.

On mounting the transducer, it is important to note that the sensor is not screwed in at an angle and that the sensor does not fall into the bore. It is of vital importance that the force for installing the sensor must only be applied at the shaft (hexagon). Do not apply any force to the sensor head!

Starting torque for 1/2-20 UNF = max. 30 Nm

Starting torque for M 18 x 1,5 = max. 50 Nm

Uninstalling

The uninstalling of the pressure transducer has to be done in a heated up condition (plastic melting point). On removal of the sensor, please take note that the diaphragm is not brought into contact. It is of vital importance that the force for uninstalling the sensor must only be applied at the shaft (hexagon). Do not apply any force to the sensor head!

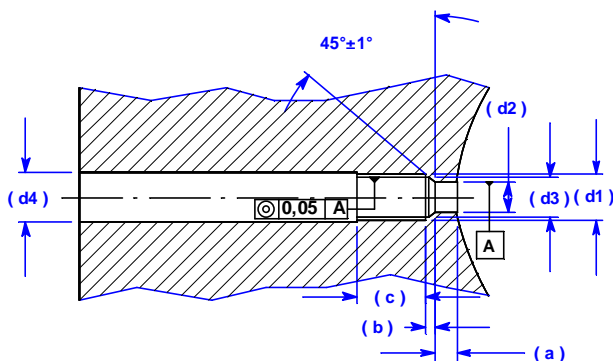

d1	M18x1,5	1/2" 20UNF 2A
d2	Ø 10,1 ^{+0,05}	Ø 7,9 ^{+0,05}
d3	Ø 16,1 ^{+0,1}	Ø 10,7 ^{+0,1}
d4	Ø 20 ^{+0,2}	Ø 13 ^{+0,2}
a	6,1 ^{-0,1}	5,7 ^{-0,1}
b	4 ^{-0,2}	3,2 ^{-0,2}
c	25	19

8. Connections and commissioning

After the pressure transducer has been installed into the line, as described in section 7, the electrical connections have to be applied according to the connections indicated on page 9. Gneuss pressure transducers are equipped with high quality and robust plug connections. The connecting wire should be soldered with great care as transmission errors of signals can otherwise occur. We recommend using Gneuss prefabricated connecting wires which are available ex-stock.

Pressure sensors of the type DAI are fitted with an integrated pressure amplifier, which depending on version can offer a standard signal in accordance to the pressure range. On commissioning, the sensor must be calibrated to the corresponding evaluation unit. **The calibration process must be carried out when the line is heated and at zero pressure.** Please proceed as described below. After successful installation and thorough heating of the pressure sensor, the zero point must be adjusted by activating the **AUTO ZERO** function.

The **AUTO ZERO** function is initiated by a short connection of the corresponding wires (see wiring configuration). For the DAI version with optical **AUTO ZERO** initiation (DAI-...-6PA) the zero point calibration can be initiated directly at the sensor. For this, remove the screw plug near the connecting plug and direct the beam of an LED flashlight into this opening for approx. 3-5 seconds.

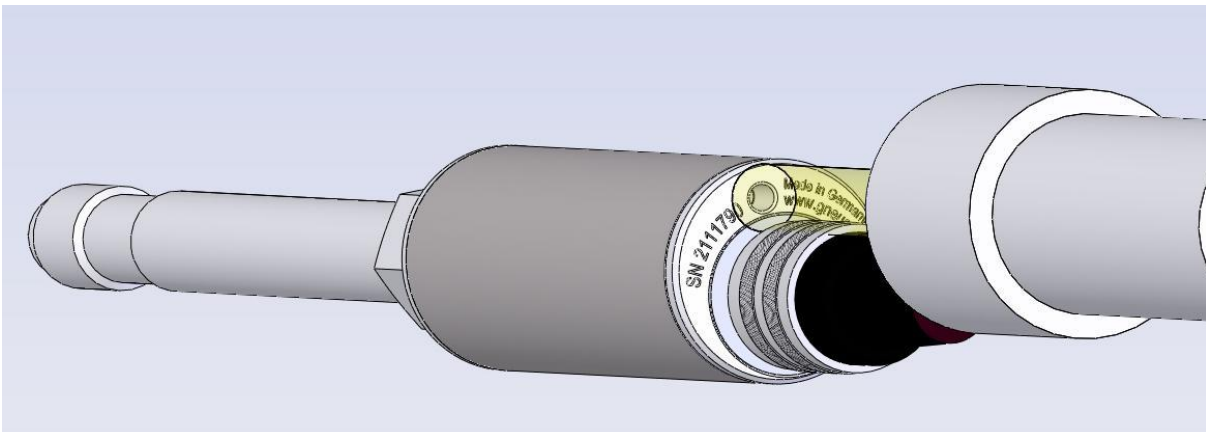

Insert the screw plug again afterwards; it simply serves for protection against contamination and extraneous light. The protection class is not impaired even without the screw plug being fitted.

The integrated amplifier will thereafter transmit the starting value of its output scale (0V at 0...10V, 0mA at 0...20mA and 4mA at 4...20mA output signal). The **AUTO ZERO** function is suppressed, if the output signal is more than 5 % of the maximum value.

Afterwards an 80% inspection of the output signal can be performed. All corresponding lead wires need to be connected for this procedure (see wiring diagram). The pressure sensor will now supply a signal which is according to 80% of the measuring value.

Electrical wiring configuration **2-Wire sensor**

Connector type: **PT02A-10-6P.**

4...20mA

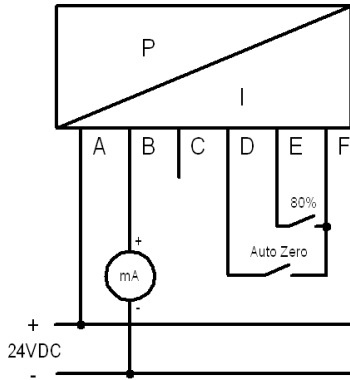
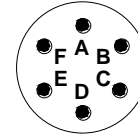

Pin	Function	Colour coding (Gneuss – cable)
A	Supply / Signal +	yellow
B	Supply / Signal -	white
C	free	brown
D	Auto Zero	green
E	80%	pink
F	Auto Zero / 80%	grey

Pin D and Pin F are utilised for the activation of the Auto-Zero function. The Zero-point is hereby merely shifted. The signal amplification is not affected, as it is shifted linear to the zero point. In order to generate the 80 % signal, pins E and F must be connected.

Electrical wiring configuration **3-Wire Sensor**

Connector type **PT02A-10-6P.**

0...10V
0/4...20mA

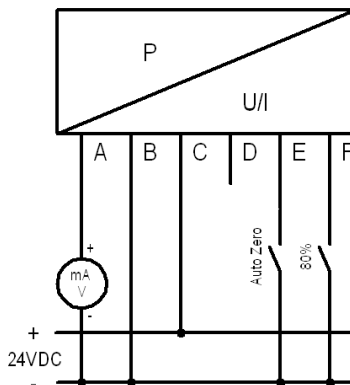
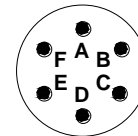

Pin	Function	Colour coding (Gneuss – cable)
A	Signal +	yellow
B	Supply /Signal/Auto Zero -	white
C	Supply +	brown
D	free	green
E	Auto Zero	pink
F	80%	grey

In order for the Auto-Zero function to be activated, pins E and B have to be connected with each other. Only the Zero-point is shifted. The signal amplification remains untouched, as it shifts linear to the zero-point. In order to generate the 80 % signal, pins F and B must be connected.

Electrical wiring configuration **4-Wire Sensor**

Connector type **PT02A-10-6P.**

0...10V
0/4...20mA

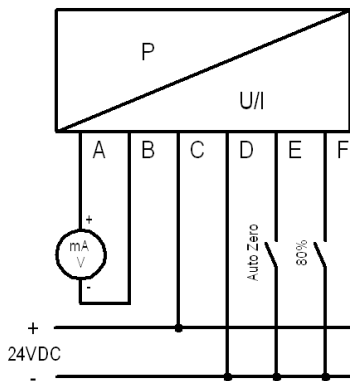
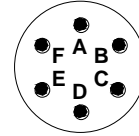

Pin	Function	Colour coding (Gneuss – cable)
A	Signal +	yellow
B	Signal/Auto Zero - *	white
C	Supply +	brown
D	Supply / Auto Zero - *	green
E	Auto Zero	pink
F	80%	grey

* Pins B and D are connected internally

In order to activate the Auto-Zero function, pins E and D or B must be connected. Only the Zero point is shifted. The signal amplification remains in place, as it shifts linear to the zero point. In order to generate the 80% signal, pins F and D or B must be connected.

Electrical wiring configuration **2-Wire sensor Version 98**

Connector type: **PT02A-98-P.**

4...20mA

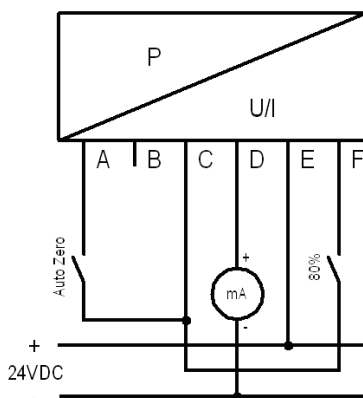
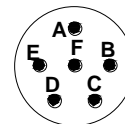

Pin	Function	Colour coding (Gneuss – cable)
A	Auto Zero	pink
B	free	yellow
C	80% / Auto Zero - *	white
D	Supply - *	green
E	Supply+	brown
F	80%	grey

* Pin C und D are connected internally

In order to activate the Auto-Zero function, pin A and pin C must be connected. Only the Zero point is shifted. The signal amplification remains in place, as it shifts linear to the zero point. In order to generate the 80% signal, pins F and C must be connected.

Electrical wiring configuration **3-Wire Sensor Version 98** Connector type **PT02A-98-P**.

0...10V
0/4...20mA

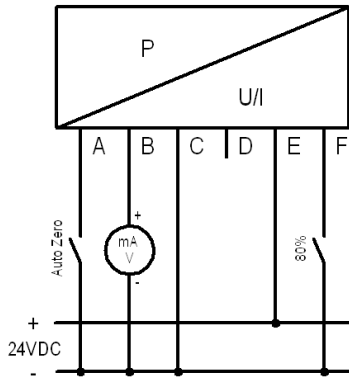
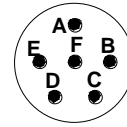

Pin	Function	Couleur coding (Gneuss – cable)
A	Auto Zero	pink
B	Signal +	yellow
C	Supply/Signal/Auto Zero -	white
D	free	green
E	Supply +	brown
F	80%	grey

In order to activate the Auto-Zero function, pins A and C have to be connected. This leads to a shifting of the zero point. The signal amplification remains in place, as it shifts linear to the zero point.

The 80 % signal is generated by connecting pins F and C

Electrical wiring configuration **4-Wire Sensor Version 98** Connector type **PT02A-98-P**.

0...10V
0/4...20mA

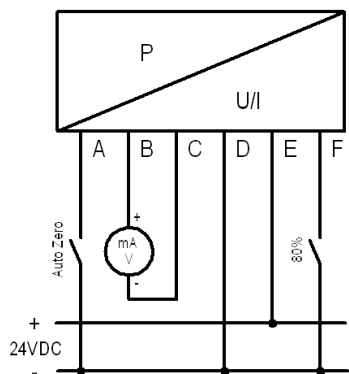
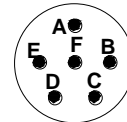

Pin	Function	Couleur coding (Gneuss – cable)
A	Auto Zero	pink
B	Signal +	yellow
C	Signal/Auto Zero - *	white
D	Supply/Auto Zero - *	green
E	Supply +	brown
F	80%	grey

* Pins C and D are connected internally

In order to activate the Auto-Zero function, pins A and C or D have to be connected. This leads to a shifting of the zero point. The signal amplification remains in place, as it shifts linear to the zero point.

The 80 % signal is generated by connecting pins F and C or D

Electrical wiring configuration **2-Wire sensor**

Connector type: **P8** (PC06A-12-8P)

4...20mA

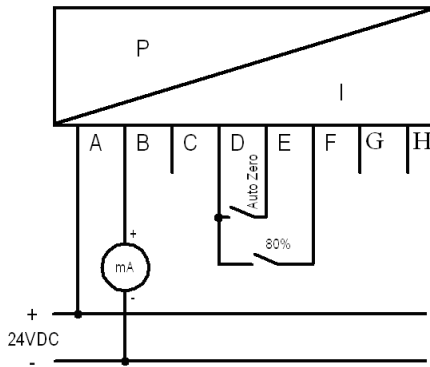
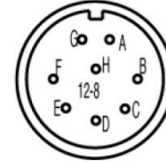

Pin	Function	Colour coding (Gneuss – cable)
A	Supply / Signal +	yellow
B	Supply / Signal -	white
C	free	brown
D	Auto Zero / 80%	green
E	Auto Zero	pink
F	80%	grey
G	free	---
H	free	---

Pin D and Pin E are utilised for the activation of the Auto-Zero function. The Zero-point is hereby merely shifted. The signal amplification is not affected, as it is shifted linear to the zero point. In order to generate the 80 % signal, pins D and F must be connected.

Electrical wiring configuration **3-Wire Sensor**

Connector type: **P8** (PC06A-12-8P)

0...10V
0/4...20mA

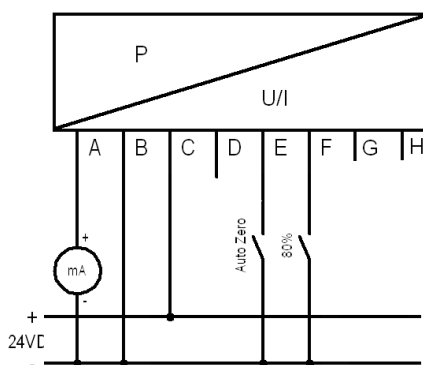
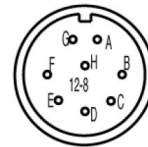

Pin	Function	Colour coding (Gneuss – cable)
A	Signal +	yellow
B	Supply / Signal -	white
C	Supply +	brown
D	free	green
E	Auto Zero	pink
F	80%	grey
G	free	---

Pin E and Pin B are utilised for the activation of the Auto-Zero function. The Zero-point is hereby merely shifted. The signal amplification is not affected, as it is shifted linear to the zero point. In order to generate the 80 % signal, pins F and B must be connected.

Electrical wiring configuration **4-Wire Sensor**

Connector type: **P8** (PC06A-12-8P)

0...10V
0/4...20mA

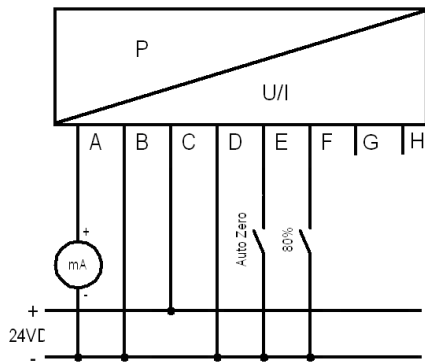
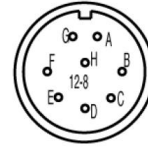

Pin	Function	Colour coding (Gneuss – cable)
A	Signal +	yellow
B	Signal -	white
C	Supply +	brown
D	Supply -	green
E	Auto Zero	pink
F	80%	grey
G	free	---
H	free	---

* Pins B and D are connected internally

Pin E and Pin D are utilised for the activation of the Auto-Zero function. The Zero-point is hereby merely shifted. The signal amplification is not affected, as it is shifted linear to the zero point. In order to generate the 80 % signal, pins F and D must be connected.

9. Technical Data:

Pressure range:	See order specification
Supply:	19...32 VDC
Output signal:	0...10 V; 0...20 mA; 4...20 mA (see order specification)
Calibration point:	80 % of measuring range
Accuracy:	0,50 % FSO respectively 0,25 % FSO (see order specification)
Maximum over load:	150% of measuring range
Zero deviation with temperature Variations at the membrane::	0,003 % from final value/°C
Zero deviation with temperature Variations at the measuring head:	0,003 % from final value/°C
Maximum temperature at the membrane:	300°C with NTX-filling (W) 400°C with Hg-filling (M) 500°C with NaK-filling (N)
Maximum. Temperature at the measuring head:	85 °C
EMC:	Electromagnetic disturbances and electromagnetic susceptibility
according to	EN 61326
Degree of protection:	IP 55

10. Dimensions

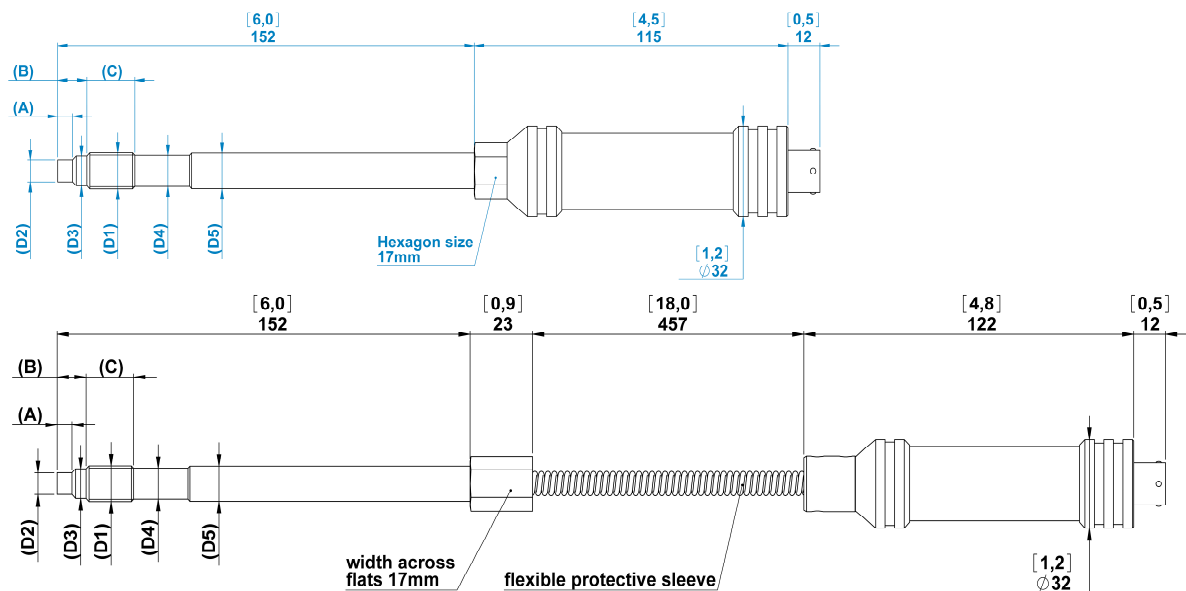

For available variations see order specification

Gneuss Kunststofftechnik GmbH
Moenichhusen 42
32549 Bad Oeynhausen, Germany
Phone: +49 (0) 5731 5307-0
Fax: +49 (0) 5731 5307-77
Mail: gneuss@gneuss.com
www.gneuss.de